

72" to 48" Precast Manhole

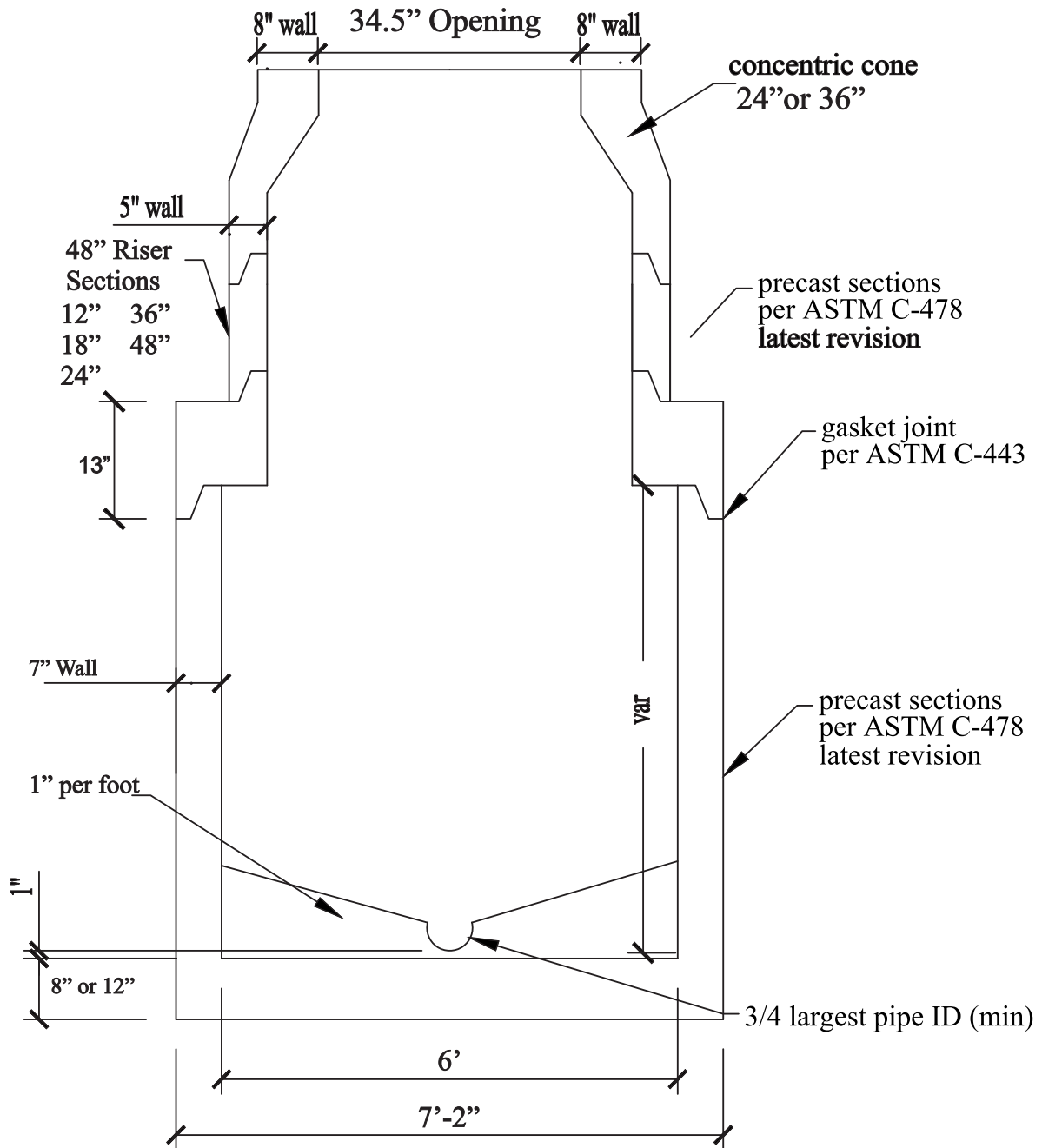

Specifications:

- Concrete has a 28 day strength of 5,000 psi
- Steel reinforcement is ASTM A615 grade 60
- Load design is H-20

